

UL File No.  
R25410



**Important General Notes:**

When UL is referred to in this document, it represents UL/ULC. This installation instruction applies to Fire Dampers and Combination Fire/Smoke Dampers mounted outside the plane of an UL approved fire partition. Combination Fire/Smoke Dampers are approved for use in Static or Dynamic Systems. The dampers are designed for operation in the vertical or horizontal position with blades running horizontal. Dampers mounted horizontally are mounted in a similar manner as those shown vertically. The dampers are to be installed square and free from twisting or racking. The dampers shall not be compressed or stretched into the opening. Transportation and installation of the dampers shall be handled with the sleeve or frame. Do not lift the damper with the blades or actuator. Special care shall be given to the damper before installation and after to insure it is protected against dirt, weather, mortar and drywall dust, wall texture and paint. Any of these conditions could cause the damper not to operate correctly and void the warranty. Suitable access to inside duct is to be provided for inspection and replacement of parts such as heat response devices and actuators per NFPA 90A and local authority having jurisdiction. The need to seal the damper in the penetration is not required by Underwriters Laboratories. UE dampers have been tested and approved to be mounted without the use of sealants around the perimeter space between the damper and the penetration. As with all joints, contractor must seal duct collar connections in the field after installation. These dampers must be ordered as an assembly from the factory with the proper UE installation applied to the dampers. UE Model numbers which are UL approved to utilize this installation are **FD-AOW, FDD-AOW, FD-BOW, FDD-BOW, F/S-3V-OW-I, F/S-3V-OW-II, F/S-AF-OW-I, F/S-AF-OW-II, F/S-3V-FA-I, F/S-3V-FA-II, F/S-AF-FA-I, F/S-AF-FA-II, FD-ASL-OW, FDD-ASL-OW, FD-110-3V-OW, FD-160-AF-OW, FDD-110-3V-OW, FDD-160-AF-OW.**

**Fig. 1: Metal Stud/Gypsum Wall Design**

**Fig. 2: Wood Stud/Gypsum Wall Design**

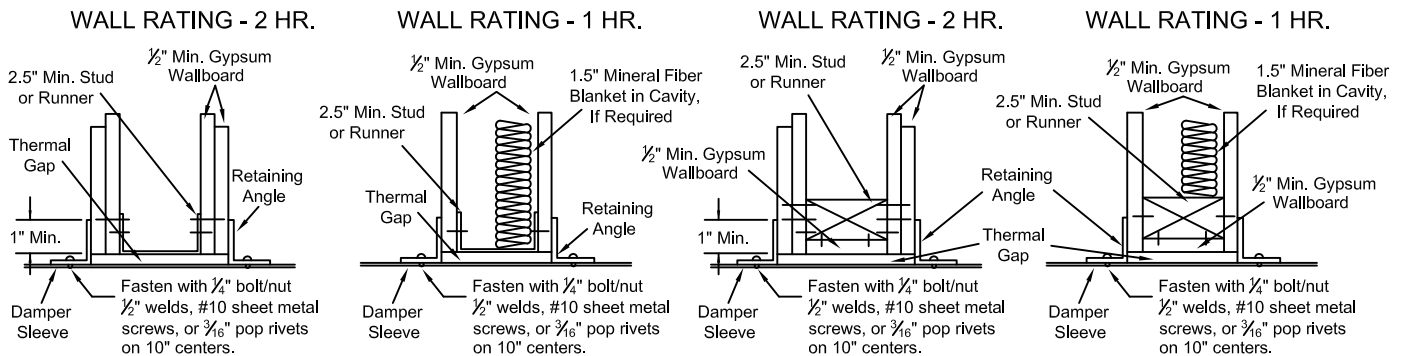

**1. Opening Preparation / Clearances:**

The fire barrier opening shall be larger than the damper to allow for thermal expansion and ease of installation. When a steel stud/gypsum partition is being used then refer to **Figs. 1 and 2** for additional information and details. The opening shall be a minimum of 1/4" (6mm) and a maximum of 1/2" (13mm). The maximum multi-section is 42" x 48" h. This method is acceptable for 1 1/2" hour fire dampers mounted in a masonry/concrete, steel stud/gypsum, or wood stud/gypsum partitions only.

**2. Damper Sleeves and Breakaway Connections:**

Sleeves shall be of the SAME GAGE or heavier as the duct to which it is attached, if one of the breakaway connection is used as defined in the SMACNA Fire, Smoke and Radiation Damper Guide for HVAC Systems (Figs. 4-6) and in NFPA 90A. Gages shall conform to SMACNA or ASHRAE duct standards. Sleeves shall not extend beyond the fire barrier more than 6" (152mm) unless an actuator or factory installed access door is supplied, then the sleeve may extend up to 16" (406mm). Sleeve shall terminate at both sides of wall within dimensions shown. If a rigid connection is used, then the sleeve shall be minimum of 16 gage for dampers up to 36" (914mm) wide by 24" (610mm) high and 14 gage for dampers exceeding 36" (914mm) wide by 24" (610mm) high. Round and oval breakaway connections must use either a 4" (102mm) wide draw band or #10 (M5) sheet metal screws spaced equally around the circumference of the duct as follows: 3 screws for duct sizes 22" (559mm) and smaller; 5 screws for duct sized greater than 22" (559mm) and up to and including 36" (914mm); 8 screws for duct sizes greater than 36" (914mm). Refer to SMACNA Fire, Smoke and Radiation Damper Guide for HVAC Systems for information on Ductmate, Nexus, Ward, TDC and TDF systems and any additional information (Figs. 5-6). A sleeve may not be required if the damper frame is of sufficient size and shape so the mounting angles can be directly fastened to it.

Note: Gypsum panels screwed to all studs and runner flanges, 12" oc maximum surrounding opening. All fasteners are to be UL approved per UL design.

Fig. 3: Metal or Wood Stud Wall

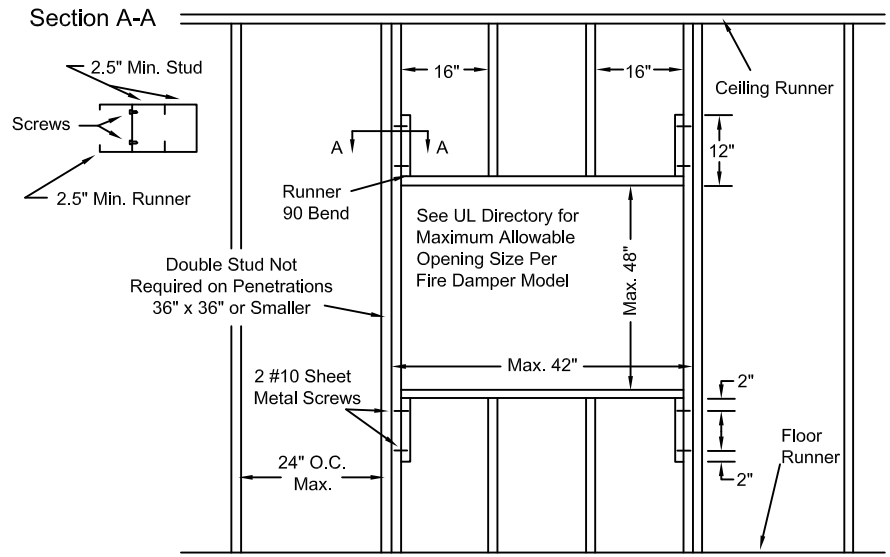

**3. Methods of Securing Damper In Opening:**

**a. Grille Mount Method:**

In this method No angles are used to secure the damper in the opening. This method is approved for use in UL approved concrete/masonry partitions and steel or wood stud/gypsum walls. This method uses a minimum 3/4" (19mm) flange on one end of the sleeve. The damper/sleeve assembly is placed in the opening so that the flange rests flush up to the partition, then the fasteners are placed through the sleeve into the partition (Fig. 7). No Angle Method is approved for 1-1/2 hour dampers only, vertical and horizontal (flange on top side only) orientations, and the maximum size shall be 42" (1067mm)

wide by 48" (1219mm) high up to the maximum multi-section UL approved damper size (See Underwriter's Laboratories Listings for maximum assembly sizes). The sleeve flange shall be a minimum of 3/4" (19mm) high by 20 gauge steel. If a flange/angle is added, it shall be a minimum of 1" x 1" (25mm x 25mm) by 18 gauge steel and fastened with #10 (M5) bolts or screws, 1/2" (13mm) welds, or 3/16" (5mm) rivets to the sleeve, at a maximum spacing of 6" (152mm) o.c. not more than 2" (51mm) from each end with a minimum of two fasteners per side. The sleeve is to be fastened to the fire partition with: In concrete/masonry partitions with #10 self-tapping concrete anchors or concrete screws on 6" (152mm) centers and must engage the fire partition a minimum of 1 1/2" (36mm); In steel stud/gypsum partitions secure the angles to the partition with #10 (M5) screws long enough to penetrate the J-Runners and E-Stud by a minimum of 3/8" (10mm). Use a minimum of two fasteners per side. The sleeve flange can be placed in front of or behind the drywall attaching directly to the studs or masonry. Be sure to not stretch the damper when securing it into the partition. Stretching the damper can cause it to bind up and prevent it from operating properly. UE's Frame Retaining Angles (ANG) can be used in place of the angle mentioned above. See note 1 for information on clearances. See Fig. 7 for detailed drawings and installations.

**b. Continuous Duct Method:** In this method 1 set of angles are used to secure the damper in the opening. This method is approved for use in UL approved concrete/masonry partitions and steel or wood stud/gypsum walls. Only one side of the fire partition will have the angles installed (see Fig. 8). One Angle Method is approved for 1-1/2 hour dampers only, vertical and horizontal (angles on top side only) orientations, and the maximum size shall be 42" wide x 48" high up to the maximum multi-section UL approved damper size (see Underwriter's Laboratories Listings for maximum assembly sizes). Angle shall be a minimum of 1-1/2" x 1-1/2" (37mm x 37mm) by 16 gauge. Angles are to be fastened to the sleeve on 6" centers with #10 (M5) sheet metal screws, 3/16" (5mm) steel pop rivets, 1/2" (13mm) tack welds, or 1/4" (6mm) diameter nut and bolts with not more than 2" (51mm) from each end with a minimum of two connections on each side/leg top and bottom. The angles are also to be fastened to the fire partition with: in concrete/masonry partitions with #10 (M5) self-tapping concrete anchors or concrete screws on 6" (152mm) centers and must engage the fire partition a minimum of 1-1/2" (38mm); in steel stud/gypsum partitions secure the angles to the partition with #10 (M5) screws long enough to penetrate the J-Runners and E-Stud by a minimum of 3/8" (10mm). Use a minimum of two fasteners per side. The angles are to overlap the partition a minimum of 1" (25mm). These angles may be of a unit type construction and may or may not be fastened to each other at the corners. When the duct work terminates at the damper or installation prohibits angles from turning out/away from the wall, the retaining angle shall be reversed (leg turned into the opening) providing the size of the opening is increased by an amount equal to twice the combined thickness of the angle and the height of the screw or bolt head to maintain expansion clearances. Angles can be placed in front of or behind the drywall attaching directly to the studs or masonry. U.E.'s Frame Retaining Angles (ANG) can be used in place of the angle mentioned above. See note 1 for information on clearances. See Fig. 8 for detailed drawings of installations. Actuator Connections (if applicable): Electric and/or pneumatic connections to damper actuators (if provided) should be made in accordance with wiring and piping diagrams developed in compliance with applicable codes, ordinances and regulations. Be sure to check actuator for proper voltage and current draw. Tampering with the actuator's installation or connecting the actuator to an improper voltage and current may void the warranty.



**ADD-ON FLANGE BREAKAWAY CONNECTIONS**

**Manufactured Flanged System Breakaway Connections**

Flanged connection systems manufactured by Ductmate, Ward, and Nexus are approved as breakaway connections when installed as illustrated.

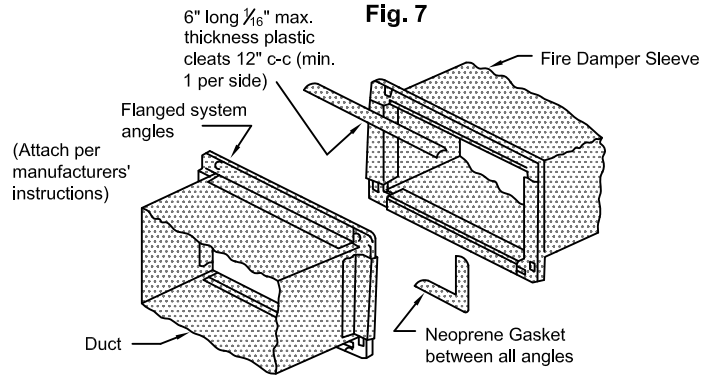

3/8" bolts may be used to align the corners. The bolt does not have to be removed.

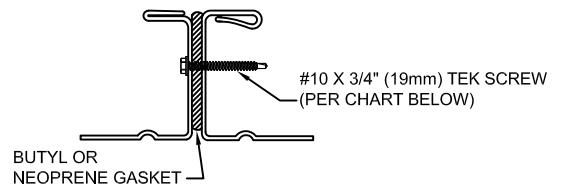
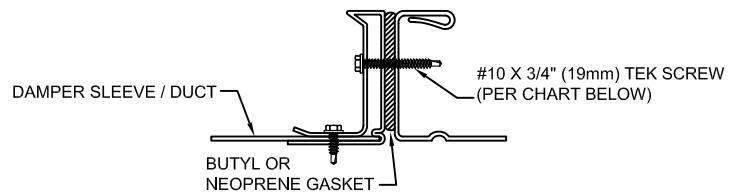
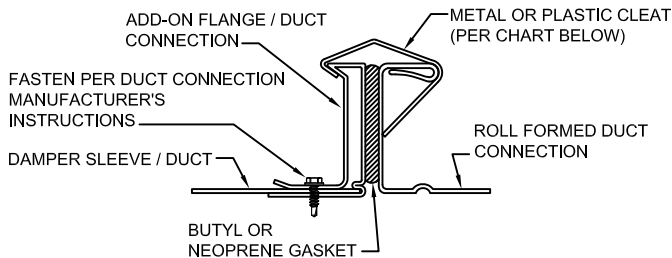
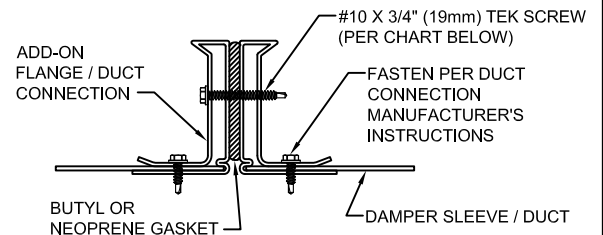
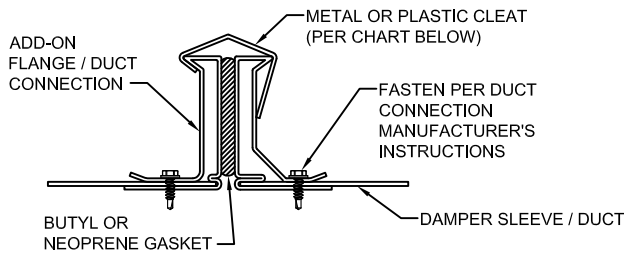

Size	Cleats	Screws
w or h < 24"	1 per side (metal or plastic)	#10x3/4" (1 per side)
w or h 24" ≤ 36"	2 per side (metal or plastic)	#10x3/4" (2 per side)
w or h 36" ≤ 54"	3 per side (metal or plastic)	#10x3/4" (3 per side)
w or h 54" ≤ 72"	4 per side (metal or plastic)	#10x3/4" (4 per side)
w or h ≤ 72"	5 per side (metal or plastic)	#10x3/4" (5 per side)

Fig. 7 - Grille Mount (No Angle) Method

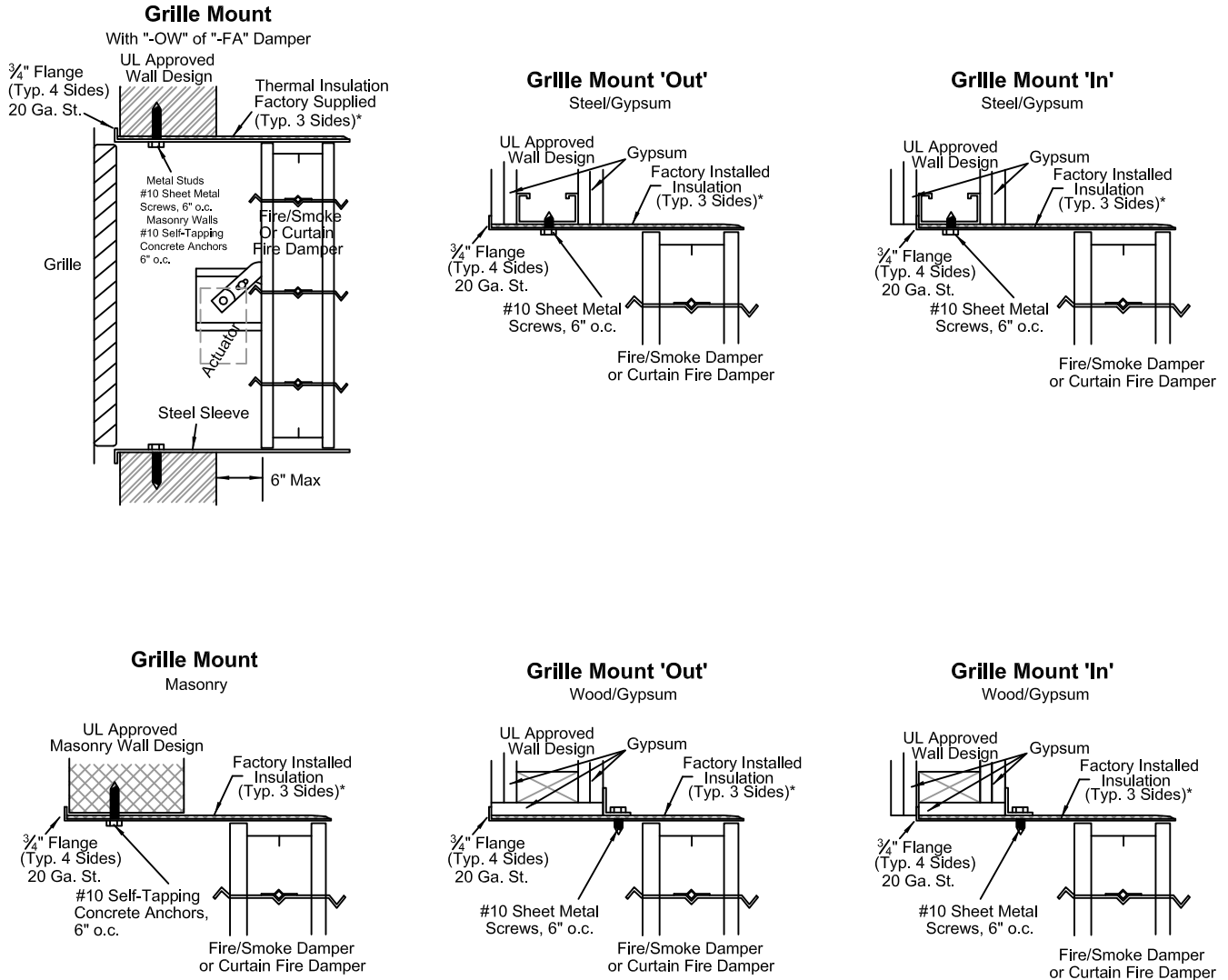

\*Typical 3 sides when mounted vertically as shown, or typical 4 sides when mounted horizontally.

The curtain and airfoil blade type fire damper installation in the same as the 3-V blade type fire damper shown.  
This instruction sheet has been reviewed and accepted by Underwriters Laboratories.

Fig. 8 - Continuous Duct (One Angle) Method

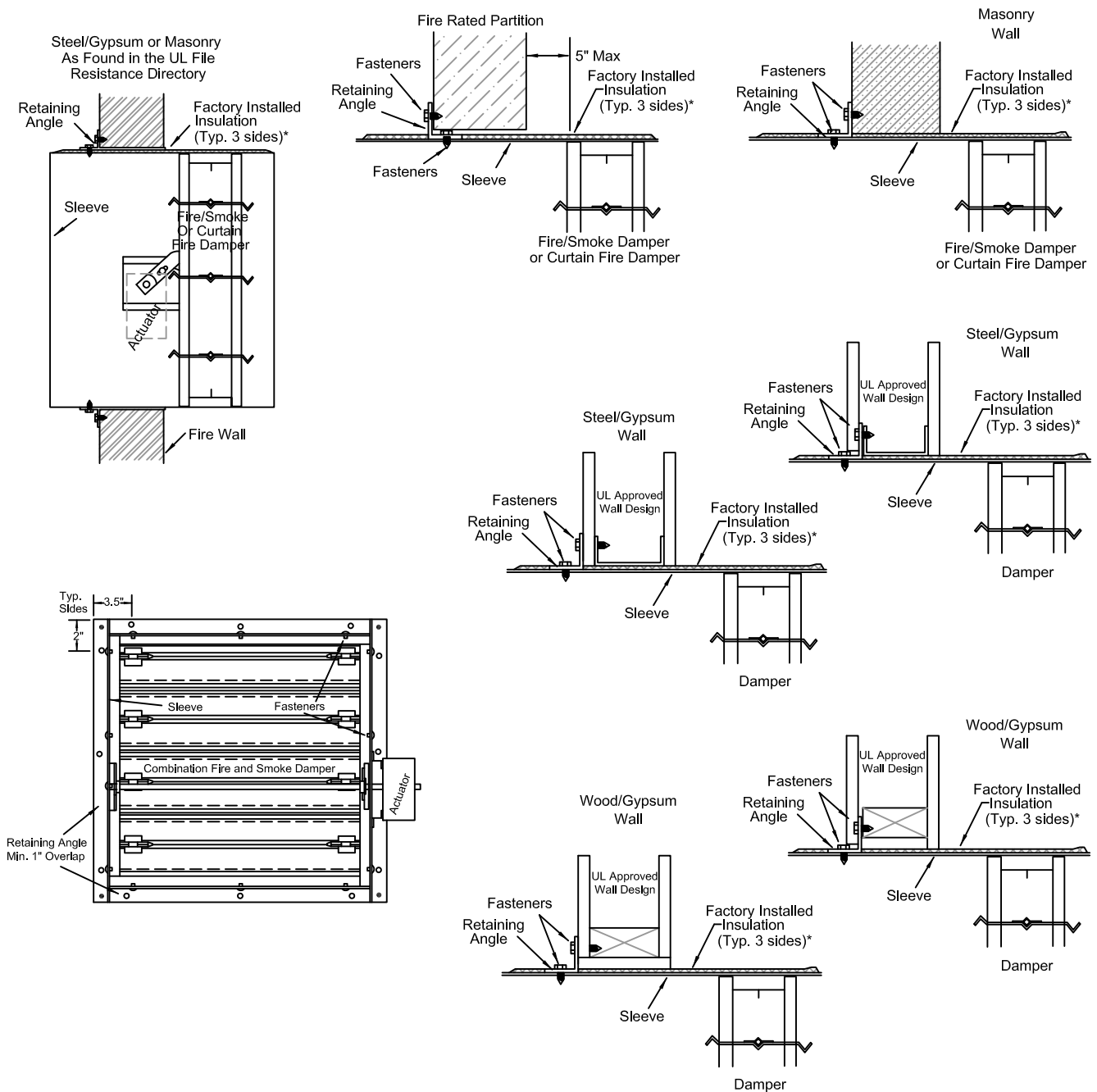

\*Typical 3 sides when mounted vertically as shown, or typical 4 sides when mounted horizontally.

The curtain and airfoil blade type fire damper installation in the same as the 3-V blade type fire damper shown.  
This instruction sheet has been reviewed and accepted by Underwriters Laboratories.